



MOULDED-PLASTIC ENCLOSURE FOR WALL MOUNTING, DEGREE OF PROTECTION IP55, WITH N AND PE TERMINAL, 72MM

Certificates/ approvals:

General Product Approval

Declaration of Conformity

Test Certificates



[Special Test Certificate](#)

Shipping Approval



other

[Confirmation](#)

[Declaration of Conformity](#)

[other](#)

[Environmental Confirmations](#)

Further information:

Information- and Downloadcenter (Catalogs, Brochures,...)

<http://www.siemens.com/industrial-controls/catalogs>

Industry Mall (Online ordering system)

<http://www.siemens.com/industrial-controls/mall>

Cax online generator

<http://www.siemens.com/cax>

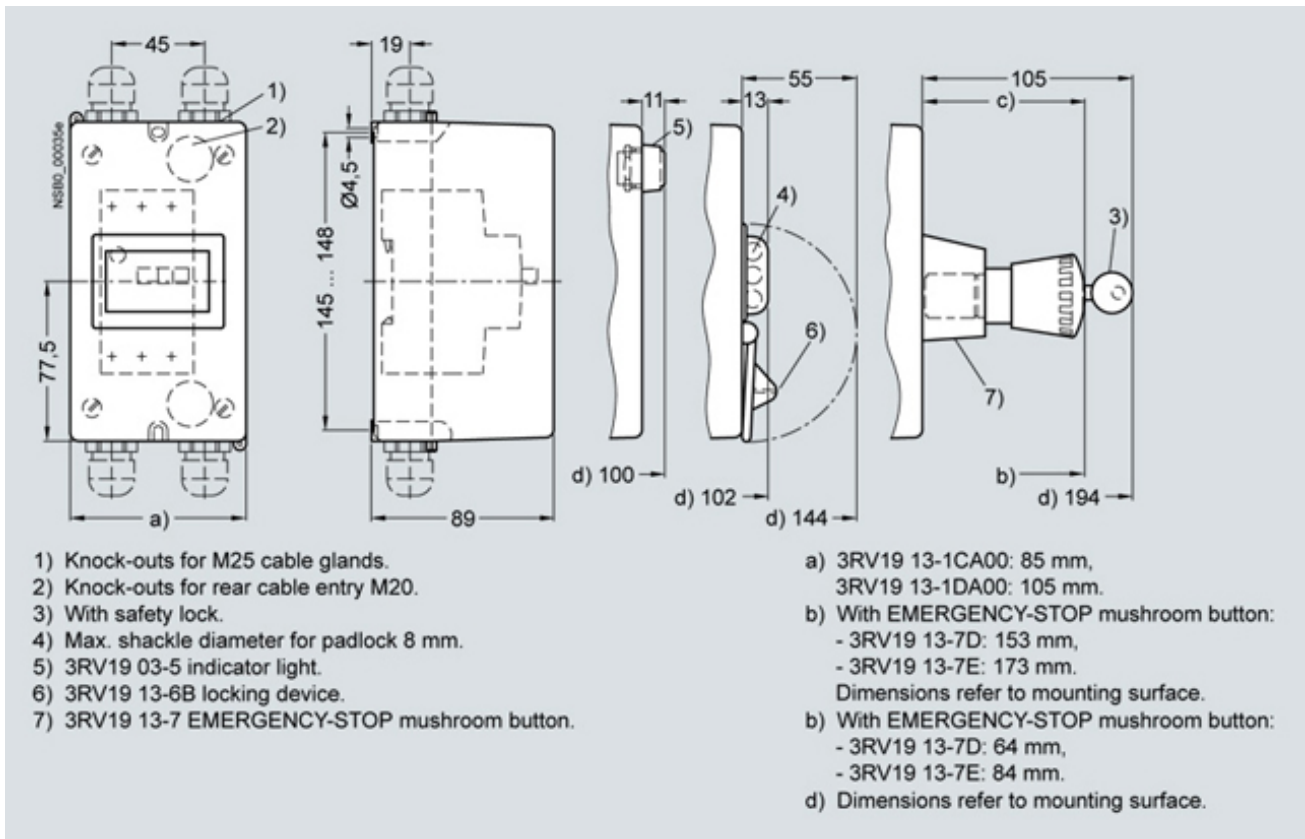

last change: